

I2C Functional Description

Applicable to following sensors

SFM3000, SFM3200, SFM3300, SFM3400

I2C details for other SFM sensors are directly included in the sensor's datasheet

Key content

- I2C communication details
- Command set and data transfer sequences
- Reset, limitations and extended command sets

Summary

This document describes the I2C communication with the SFM3xxx sensor series. Communication between the master and the SFM3xxx series sensor runs via the digital I2C-interface. This document contains all essential as well as several extended commands and some basic descriptions of the SFM3xxx series I2C protocol. For the detailed specifications please check the NXP document "The I2C-Bus Specification".

1 Interface connection

Bi-directional bus lines are implemented by the devices (master and slave) using open-drain output stages and a pull-up resistor (R_p) connected to the positive supply voltage.

The recommended pull-up resistor value depends on the system setup, particularly on the capacitance of the circuit or cable and bus clock frequency. For quick prototyping a value of 10kOhm is a reasonable choice. Please refer to NXP's I2C bus specification in order to determine the optimal value.

The capacitive loads on SDA and SCL line have to be the same. It is important to avoid asymmetric capacitive loads. In case of long wires (>10cm) it is necessary to shield SDA and SCL. Wires longer than 30cm should not be used.

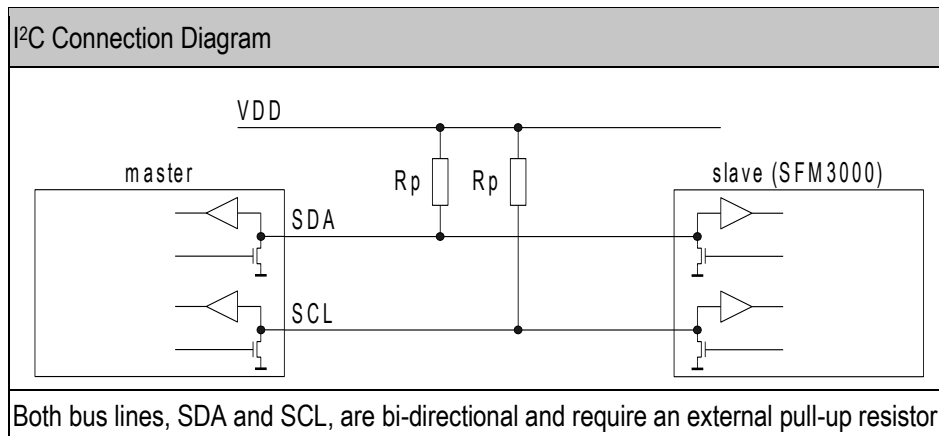

2 I2C Address

The I2C address is represented by a 7-digit binary value. By default, the I2C address is set to 64 (1000000b). The address is always followed by a write bit (0) or read bit (1). The default hexadecimal I2C header for read access to the sensor is therefore 0x81.

3 I2C communication

The I2C protocol consists of start and stop conditions at the beginning and ending of the transfers and a number of 8 bit frames in between, of which each frame is acknowledged in case of a successful transmission.

3.1 Transmission START Condition (S)

The START condition is a unique situation on the bus created by the master, indicating to the slaves the beginning of a transmission sequence (the bus is considered busy after a START).

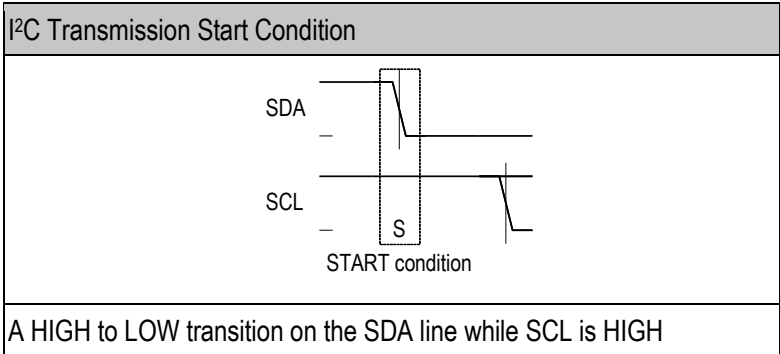

3.2 Transmission STOP Condition (P)

The STOP condition is a unique situation on the bus created by the master, indicating to the slaves the end of a transmission sequence (the bus is considered free after a STOP).

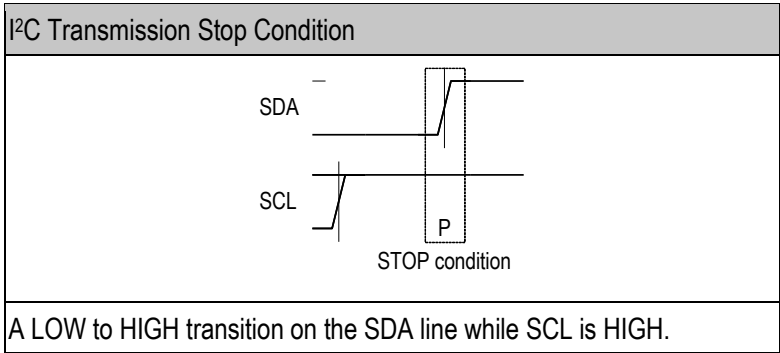

3.3 Acknowledge (ACK) / Not Acknowledge (NACK)

Each byte transmitted over the I2C bus is followed by an acknowledge condition from the receiver. This means that after the master pulls SCL low to complete the transmission of the 8th bit, SDA will be pulled low by the receiver during the 9th bit time. If after transmission of the 8th bit the receiver does not pull the SDA line low, this is considered to be a NACK condition.

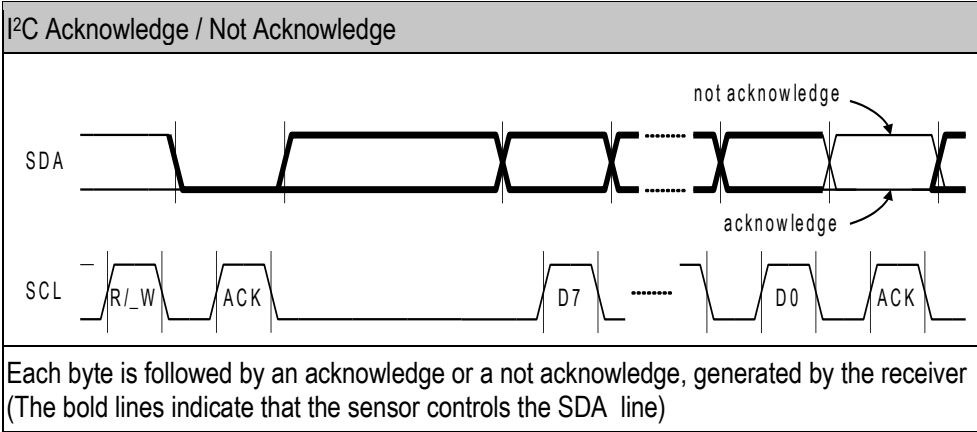

3.4 Data transfer format

Data is transferred in byte packets in the I2C protocol. Each byte is followed by an acknowledge bit. Data is transferred with the most significant bit first.

A data transfer sequence is initiated by the master generating the Start condition (S) and sending a header byte. The I2C header consists of the 7-bit I2C device address and the data direction bit (R/_W).

The value of the R/_W bit in the header determines the data direction for the rest of the data transfer sequence. If R/_W = 0 (WRITE) the direction remains master-to-slave, while if R/_W = 1 (READ) the direction changes to slave-to-master after the header byte.

4 Command Set and Data Transfer Sequences

After a data transfer is initiated by a header byte with a Write, a command is sent to the slave. A command is represented by a 16-bit command code, consisting of two 8-bit frames. The data direction may not change after the command bytes, since the R/W bit of the preceding I2C header has already determined the direction to be master-to-slave. In order to execute Read commands, the following principle is used. On successful (acknowledged) receipt of the command code, the sensor stores the command internally. The Read part of this command is then invoked by initiating an I2C data transfer sequence with R/W = 1.

If a correctly addressed sensor recognizes a valid command and access to this command is granted, it responds by pulling down the SDA line during the subsequent SCL pulse for the acknowledge signal (ACK). Otherwise it leaves the SDA line unasserted (NACK).

The commands are described below, and the data transfer sequences are specified.

Command [16 bit]	Number of bytes to read back	Command Description	Comment
0x1000	2	Start continuous measurement and/or move internal pointer (back) to flow measurement result register	See chapter 4.1
0x31AE	4	Read Serial Number (bit 31:0)	See chapter 4.2
0x2000	NA	Soft reset command	See chapter 6

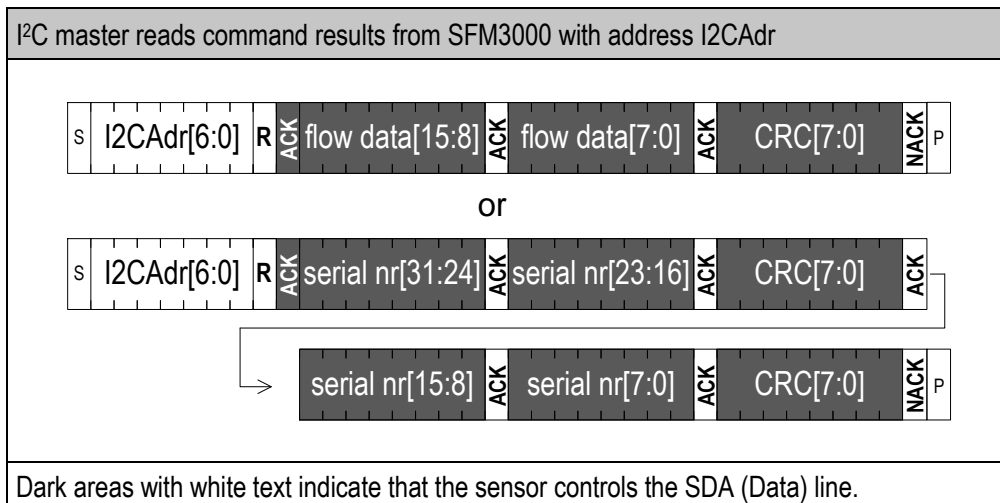
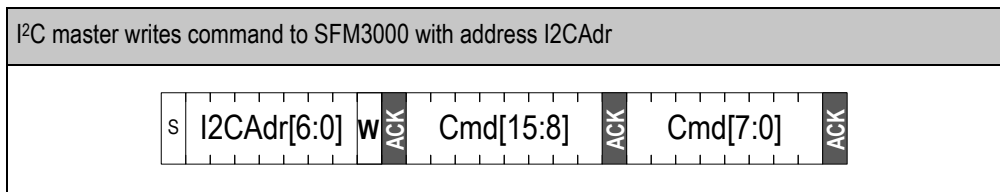

4.1 Measurement Triggering

Flow measurements are started by writing the start measurement command (0x1000) to the sensor. Measurement results are continuously updated until measurement is stopped by sending any other command. After a start measurement command, the measurement results can be read out continuously. This means that an I2C header with R/W bit = 1 can be sent continuously to read out those results, without preceding it with command 0x1000.

The measurement result register is set to invalid after being read and only set to valid again when a new measurement result is available. If no valid result available, the chip does not acknowledge a read.

Timing for SFM3000 (see below table for other SFM3xxx)			
Δ time (ms)	I^2C communication	Measuring?	Comment
0	-	No	Powering up of the sensor (heater powered up with start up)
100	80 _a 10 _a 00 _a	→ Yes	After the sensor is out of reset, the start measurement command is sent
0.5	81 _n FF _a FF _a FF _n	Yes	First measurement result read out after chip reset is invalid
0.5	81 _a F0 _a 00 _a CRC _n	Yes	Valid measurement data is read out + CRC byte.
0.5	81 _a F0 _a 14 _n	Yes	Updated flow value is read out. CRC is not read out.
0.4	81 _n	Yes	No valid measurement data is ready yet. The read request is not acknowledged
0.1	81 _a F0 _a 28 _a CRC _n	Yes	New measurement data is available and read out.
1	80 _a 31 _a AE _a	→ No	Send read serial number command
0.2	81 _a 5A _a D8 _a CRC _a 47 _a 40 _a CRC _n	No	Read example serial number
0.3	80 _a 10 _a 00 _a	→ Yes	Start measurement command is sent
0.5	81 _a F0 _a 00 _a CRC _n	Yes	Measurement data is read out + CRC byte.
Dark areas with white text indicate that the sensor controls the SDA (Data) line. An _a indicates and ACK, an _n indicates a NACK			

The table below gives an example sequence with explanations for every command.

Timing for SFM3200, SFM3300 and SFM3400			
Δ time (ms)	I^2C communication	Measuring?	Comment
0	-	No	Powering up of the sensor
40	80 _a 10 _a 00 _a	No	After the sensor is out of reset, the start measurement command is sent (heater is started)
100	81 _n FF _a FF _a FF _n	Yes	First measurement result read out after chip reset is invalid
0.5	81 _a F0 _a 00 _a CRC _n	Yes	Valid measurement data is read out + CRC byte.
0.5	81 _a F0 _a 14 _n	Yes	Updated flow value is read out. CRC is not read out.
0.4	81 _n	Yes	No valid measurement data is ready yet. The read request is not acknowledged
0.1	81 _a F0 _a 28 _a CRC _n	Yes	New measurement data is available and read out.
1	80 _a 31 _a AE _a	→ No	Send read serial number command
0.2	81 _a 5A _a D8 _a CRC _a 47 _a 40 _a CRC _n	No	Read example serial number
0.3	80 _a 10 _a 00 _a	→ Yes	Start measurement command is sent
0.5	81 _a F0 _a 00 _a CRC _n	Yes	Measurement data is read out + CRC byte.
Dark areas with white text indicate that the sensor controls the SDA (Data) line. An _a indicates and ACK, an _n indicates a NACK			

Note that if the supply drops below 4.75V and back, the sensor will perform a Power on Reset and will stop measuring. If the master keeps on sending read headers without resending the start measurement command, those read requests will not be acknowledged. It is advised to have a software routine that detects those NACKs and resends the start measurement command. If the sensor does not acknowledge the start measurement command, a hard reset is required.

4.2 Read Data Layout

Data that is read back from the Sensor consists of two or four bytes, with the most significant byte and bit read first. The least significant bit and byte are read last. The following maps give more details on the content of the different results:

Read flow measurement result

Bit	#Bits	Description/Coding
15:0	16	Flow measurement result. Bit <1:0> is always zero.

Read serial number

Command	#Bits	Description/Coding
0x31AE	32	Bit 31:0 of the unique serial number

4.3 Converting measurement result to measured values

In order to obtain the measured flow in the predefined unit, the flow measurement result needs to be converted according to the following formula:

$$flow [slm] = \frac{measured\ value - offset\ flow}{scale\ factor\ flow}$$

Offset and scale factor can be found in the product datasheet.

Please note that the first measurement performed directly after chip initialization might not be valid.

5 CRC-8 Redundant Data Transmission

Cyclic redundancy checking (CRC) is a popular technique used for error detection in data transmission. The transmitter appends an n-bit checksum to the actual data sequence. The checksum holds redundant information about the data sequence and allows the receiver to detect transmission errors. The computed checksum can be regarded as the remainder of a polynomial division, where the dividend is the binary polynomial defined by the data sequence and the divisor is a “generator polynomial”.

The SFM3000 sensor implements the CRC-8 standard based on the generator polynomial: $x^8 + x^5 + x^4 + 1$. (0x31)

Note that CRC is only used for data transmitted from the slave to the master.

For details regarding cyclic redundancy checking, please refer to the AppNote SFM-04 “CRC Checksum” on our website and the relevant literature.

6 Soft reset

The soft reset command forces a sensor reset without switching the power off and on again. On receipt of this command, the sensor reinitializes the control/status register contents from the non-volatile memory and starts operating according to these settings.

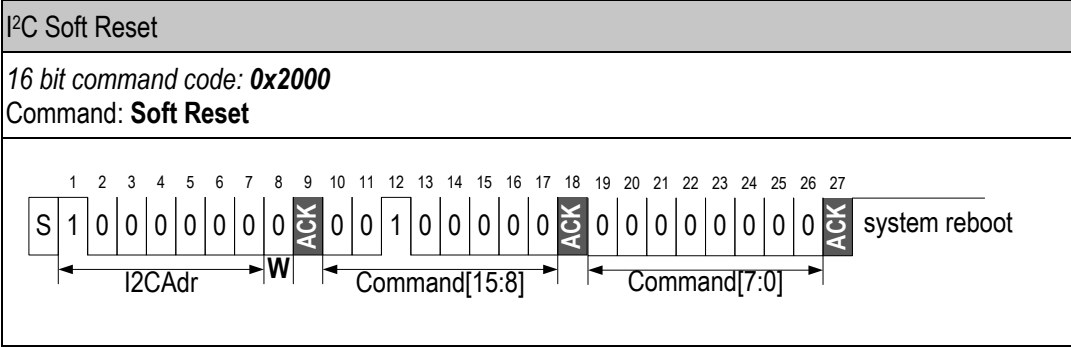

7 Limitations

The I²C interface of the SFM3xxx show deviations from the NXP I²C specification and might lock up and cease to react (including to the soft reset command), under the following conditions:

- Glitches on the SCL.
- The master does not acknowledge the first byte read from the sensor after having sent the header byte (I²C address + R bit). The critical acknowledge bit is highlighted below.

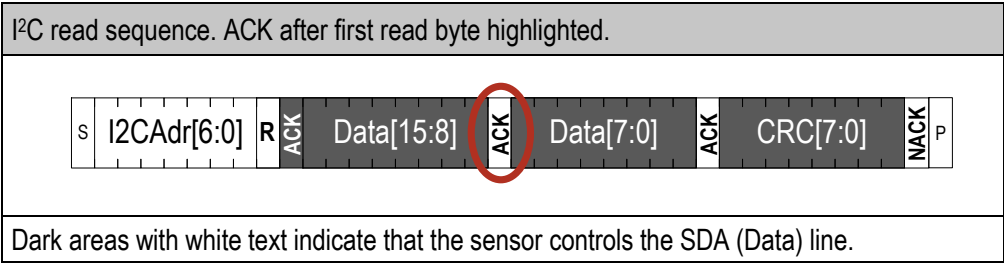

To avoid these phenomena from occurring it is essential to take the following precautions:

- The cable length from the sensor to the microprocessor is recommended to be as short as possible and certainly not longer than 30 cm. For wires longer than 10 cm the SDA and SCL must be shielded. Sources that emit electromagnetic radiation must be kept away from the I²C connection.
- When data is read from the sensor, one must ensure that the first data byte of the transaction is always acknowledged by the master.
- It must be possible to reset the sensor through a hard reset, i.e. powering off and on the sensor, in case the sensor freezes.

8 Extended Command Set

Task	Command [16 bit]	# of bytes to read back	Detailed Command Description
Start flow measurement	0x1000	2	Start continuous measurement and/or move internal pointer to flow measurement result register
Start temperature measurement*	0x1001	2	Start continuous measurement and/or move internal pointer to temperature measurement result register. Bit <1:0> are always zero.
Read scale factor	0x30DE	2	Combining both bytes yields the flow scale factor
Read offset	0x30DF	2	Combining both bytes yields the flow offset
Read article number	0x31E3	2	In order to read out the product type/article number, two commands have to be sent to the sensor resulting in 4 bytes of data (bits <31:0>). The command 0x31E3 results in the first two bytes (bits <31:16>) followed by command 0x31E4 with another two bytes (bits <15:0>).
	0x31E4	2	
Read serial number	0x31AE	2	In order to read out the serial number, two commands have to be sent to the sensor resulting in 4 bytes of data (bits <31:0>). The command 0x31AE results in the first two bytes (bits <31:16>) followed by command 0x31AF with another two bytes (bits <15:0>).
	0x31AF	2	
Soft reset	0x2000	NA	Soft reset command

SFM3xxx-AW versions only! There is an additional EEPROM on the SFM3300-AW and SFM3400-AW to allow storage of customer-specific data (e.g. usage hours). Please see all details in the datasheet of the EEPROM. The EEPROM is of type 24LC01BT-I/MC. No additional validation or modification of EEPROM settings has been performed by Sensirion.

*Allows read out of the chip temperature. Please note that the sensor temperature does not necessarily reflect the temperature of the gas flowing through the sensor. See additional AppNote SFM-08 "Temperature Effects".

9 Revision history

<i>Date</i>	<i>Author</i>	<i>Version</i>	<i>Changes</i>
July 2013	ANB	1	First release
July 2015	ANB	1.1	Added Read Serial Number Command. Minor changes.
Jan 2021	PSIM	1.2	Added Extended I2C Command Set and applicability to further SFM3x00 sensors

10 Headquarters and Subsidiaries

SENSIRION AG
 Laubisruestr. 50
 CH-8712 Staefa ZH
 Switzerland
 phone: +41 44 306 40 00
 fax: +41 44 306 40 30
 info@sensirion.com
www.sensirion.com

Sensirion Inc., USA
 phone: +1 805 409 4900
 info_us@sensirion.com
www.sensirion.com

Sensirion Japan Co. Ltd.
 phone: +81 3 3444 4940
 info@sensirion.co.jp
www.sensirion.co.jp

Sensirion Korea Co. Ltd.
 phone: +82 31 337 7700 3
 info@sensirion.co.kr
www.sensirion.co.kr

Sensirion China Co. Ltd.
 phone: +86 755 8252 1501
 info@sensirion.com.cn
www.sensirion.com.cn

Sensirion AG (Germany)
 phone: +41 44 927 11 66
 info@sensirion.com
www.sensirion.com

To find your local representative, please
 visit www.sensirion.com/contact