

# Datasheet – SHT4xA

4<sup>th</sup> Generation, High-Accuracy, Functional Safety Compliant Automotive-Grade Relative Humidity and Temperature Sensor

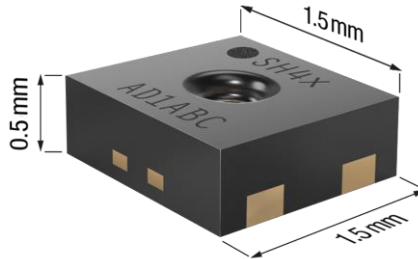

## Highlights

- Relative humidity accuracy: up to  $\pm 2$  %RH
- Temperature accuracy: up to  $\pm 0.2$  °C
- VDD: (1.08 V ... 3.6 V) & 2.3 V ... 5.5 V
- I2C FM+, CRC checksum, multip. I2C addr.
- Pulse-width modulation interface
- Operating range: 0 ... 100 %RH, -40 ... 125 °C
- Designed for 85 °C/85 %RH reliability testing
- Fully functional in condensing environment
- Variable power heater
- AEC Q100 qualification, high-reliability design
- Mature technology from global market leader
- Available as a Safety Element out of context (ASIL-A SEooC)
- developed according to ISO 26262

SHT4xA is an automotive-grade digital sensor platform for measuring relative humidity and temperature with different accuracy gradings. It fulfills demanding reliability requirements for automotive applications, such as 85 °C/85 %RH accelerated life tests and is available as ASIL A Safety Element out of Context (SEooC) developed according to ISO 26262. The sensors can be interfaced via I2C or pulse-width modulation. An integrated heater allows for advanced on-board diagnostics while the sensor element is designed for reliable operation in harsh conditions such as condensing environments. The four-pin dual-flat-no-leads package is suitable for surface mount technology (SMT) processing and can be ordered with a wettable flanks option

## Device Overview

Product	Details
SHT41A-AD1B	$\pm 2$ %RH / $\pm 0.3$ °C, I2C, DFN, 2.3 V ... 5.5 V
SHT41A-AW1B	$\pm 2$ %RH / $\pm 0.2$ °C, I2C, wettable flanks, 2.3 V ... 5.5 V
SHT41A-AWSB	$\pm 2$ %RH / $\pm 0.2$ °C, I2C, wettable flanks, 2.3 V ... 5.5 V, ASIL-A SEooC
SHT41A-FD1B	$\pm 2$ %RH / $\pm 0.2$ °C, PWM interface, 2.3 V ... 5.5 V
SHT40A-AW1B	$\pm 3$ %RH / $\pm 0.3$ °C, I2C, wettable flanks, 2.3 V ... 5.5V
SHT41A-AWLb (samples avail.)	$\pm 2$ %RH / $\pm 0.2$ °C, I2C, wettable flanks, 1.08 V ... 3.6 V (low voltage)

## Functional Block Diagram

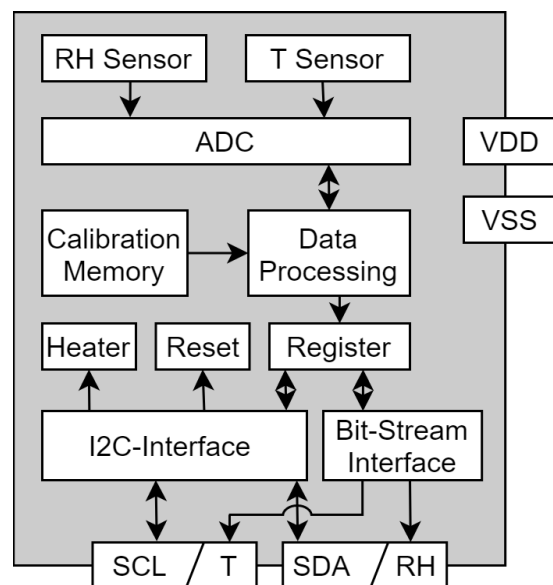

See full product list on page 22.

## Contents

1	Quick Start – Hello World.....	4
2	Humidity and Temperature Sensor Specifications .....	5
2.1	Relative Humidity .....	5
2.2	Relative Humidity Accuracy at the Extended Temperature Range.....	6
2.3	Temperature.....	7
2.4	Recommended Operating Conditions.....	8
2.5	Design In.....	8
3	Electrical Specifications .....	9
3.1	Timings.....	10
3.2	Absolute Maximum Ratings.....	11
4	Sensor Operation.....	11
4.1	I2C Communication.....	11
4.1.1	I2C Communication Timing.....	11
4.2	I2C Data type & length .....	12
4.3	I2C Checksum Calculation .....	12
4.4	I2C Command Overview.....	13
4.5	Conversion of Signal Output.....	13
4.6	Serial Number.....	14
4.7	I2C Heater Operation .....	14
4.8	Possible Heater Use Cases.....	15
4.9	Important notes for operating the heater:.....	15
4.10	Pulse-Width Modulation (PWM) interface .....	15
4.11	PWM Conversion of Signal Output.....	16
4.12	Reset.....	16
5	Physical Specification .....	16
5.1	Package Description.....	16
5.2	Package Outline – Standard Package .....	17
5.3	Package Outline – Package with Wettable Flanks .....	17
5.4	Land Pattern– Package with Wettable Flanks .....	17
5.5	Pin Assignment & Laser Marking .....	18
5.6	Thermal Information .....	19
6	Safety Element out of context (SEooC) .....	19
7	Quality and Material Contents .....	19
8	Tape and Reel Packaging .....	20
9	Product Nomenclature .....	21
10	Ordering Information.....	22
11	Bibliography.....	23

Scan me to provide feedback



Revision History.....24

# 1 Quick Start – Hello World

A typical application circuit for SHT4xA is shown on the left-hand side of **Figure 1**. After reaching the minimal supply voltage and allowing for the maximal power-up time of 1 ms the sensor is ready for I2C communication. The quickest way to measure humidity and temperature is pseudo-coded on the right-hand side of **Figure 1**. Together with the conversion formulae given in equations 1, 2 and 3, the digital signals can be translated into relative humidity and temperature readings.

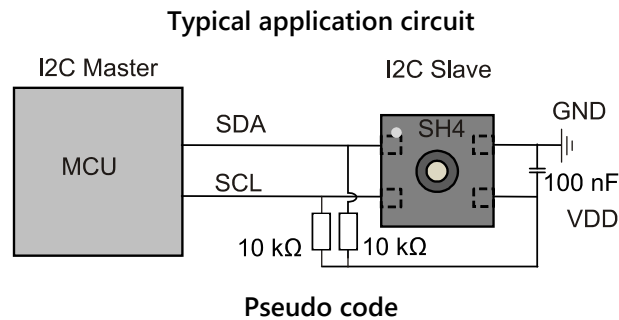

```

i2c_write(i2c_addr=0x44, tx_bytes=[0xFD])
wait_seconds(0.01)
rx_bytes = i2c_read(i2c_addr=0x44, number_of_bytes=6)
t_ticks = rx_bytes[0] * 256 + rx_bytes[1]
checksum_t = rx_bytes[2]
rh_ticks = rx_bytes[3] * 256 + rx_bytes[4]
checksum_rh = rx_bytes[5]
t_degC = -45 + 175 * t_ticks/65535
rh_pRH = -6 + 125 * rh_ticks/65535
if (rh_pRH > 100):
    rh_pRH = 100
if (rh_pRH < 0):
    rh_pRH = 0
    
```

**Figure 1.** Typical application circuit (top) and pseudo code (bottom) for easy starting. For details on the signal cropping in the last four lines see section 4.5.

Find code resources and embedded drivers on: <https://github.com/Sensirion/embedded-sht/releases>   
 CAD files are available on SnapEDA ("\*" considered as wildcard):

- SHT4\*A-\*D\*B

## 2 Humidity and Temperature Sensor Specifications

Every SHT4xA is individually tested and calibrated and is identifiable by its unique serial number (see section 4.6 for details on the serial number). For the calibration, Sensirion uses transfer standards, which are subject to a scheduled calibration procedure. The calibration of the reference, used for the calibration of the transfer standards, is NIST traceable through an ISO/IEC 17025 accredited laboratory.

### 2.1 Relative Humidity

Parameter	Conditions	Value	Units
SHT40A RH accuracy <sup>1</sup>	typ.	±3	%RH
	max.	see <b>Figure 2</b>	-
SHT41A RH accuracy <sup>1</sup>	typ.	±2	%RH
	max.	See <b>Figure 3</b>	-
Repeatability <sup>2</sup>	high	0.08	%RH
	medium	0.15	%RH
	low	0.21	%RH
Resolution <sup>3</sup>	-	0.01	%RH
Hysteresis	At 25°C	±0.8	%RH
Specified range <sup>4</sup>	extended <sup>5</sup>	0 to 100	%RH
Response time <sup>6</sup>	$t_{63\%}$	4	s
Long-term drift <sup>7</sup>	typ.	<0.20	%RH/y

**Table 1.** General relative humidity sensor specifications.

<sup>1</sup> For definition of typ. and max. accuracy, please refer to the document “Sensirion Humidity Sensor Specification Statement”.

<sup>2</sup> The stated repeatability is 3 times the standard deviation (3σ) of multiple consecutive measurement values at constant conditions and is a measure for the noise on the physical sensor output. Different repeatability commands are listed in **Table 7**.

<sup>3</sup> Resolution of A/D converter.

<sup>4</sup> Specified range refers to the range for which the humidity or temperature sensor specification is guaranteed.

<sup>5</sup> For details about recommended humidity and temperature operating range, please refer to section 2.4.

<sup>6</sup> Time for achieving 63% of a humidity step function, measured at 25 °C and 1 m/s airflow. Humidity response time in the application depends on the design-in of the sensor.

<sup>7</sup> Typical value for operation in normal RH/T operating range. Max. value is <0.5 %RH/y. Value may be higher in environments with vaporized solvents, out-gassing tapes, adhesives, packaging materials, etc. For more details, please refer to the document Handling Instruction for Humidity and Temperature Sensors [1].

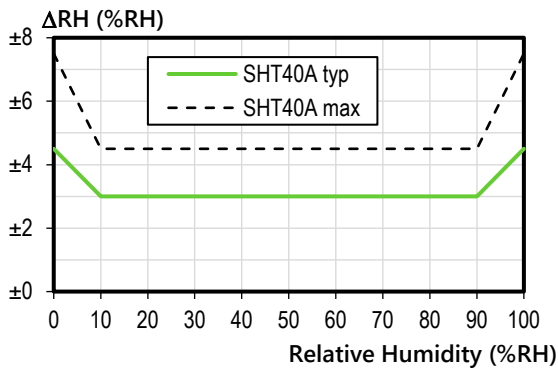

**Figure 2.** SHT40A typical and maximal relative humidity accuracy at 25 °C.

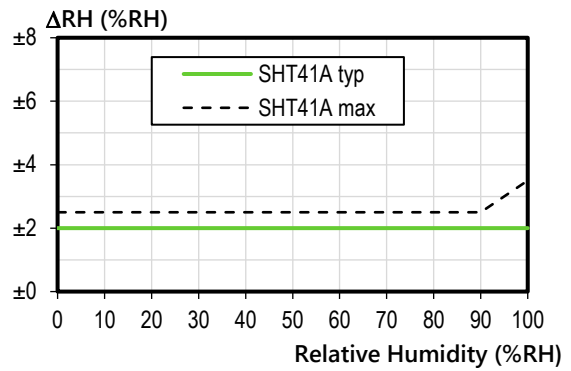

**Figure 3.** SHT41A typical and maximal relative humidity accuracy at 25 °C.

## 2.2 Relative Humidity Accuracy at the Extended Temperature Range

The typical RH accuracy tolerances in the range of T = 0 °C ... 80 °C are given in Figure 4 and Figure 5.

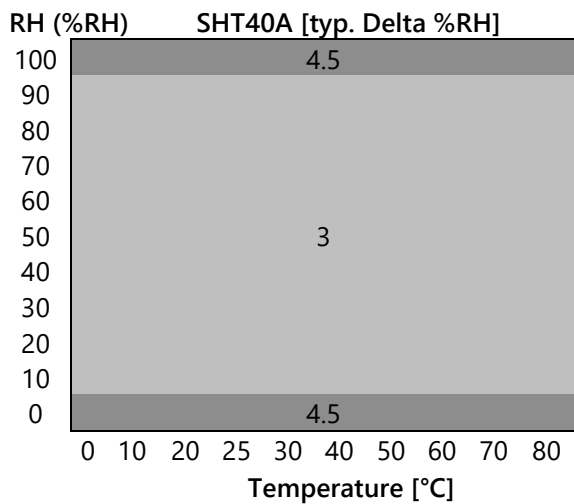

**Figure 4.** Typical RH accuracy tolerance over humidity and temperature for SHT40A.

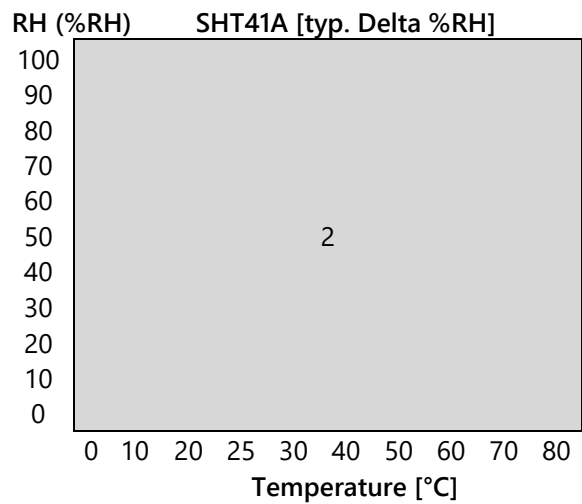
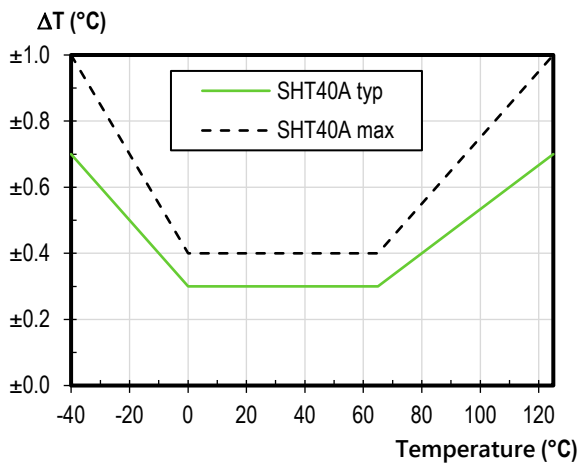

**Figure 5.** Typical RH accuracy tolerance over humidity and temperature for SHT41A.

### 2.3 Temperature

Parameter	Conditions	Value	Units
SHT40A <i>T</i> Accuracy <sup>1</sup>	typ.	±0.3	°C
	max.	see <b>Figure 6</b>	-
SHT41A <i>T</i> Accuracy <sup>1</sup>	typ.	±0.2	°C
	max.	See <b>Figure 7</b>	-
Repeatability <sup>2</sup>	high	0.04	°C
	medium	0.07	°C
	low	0.1	°C
Resolution <sup>3</sup>	-	0.01	°C
Specified range <sup>4</sup>	-	-40 to +125	°C
Response time <sup>8</sup>	$t_{63\%}$	2	s
Long-term drift <sup>9</sup>	typ.	<0.03	°C/y

**Table 2.** General temperature sensor specifications.



**Figure 6.** SHT40A typical and maximal temperature accuracy.

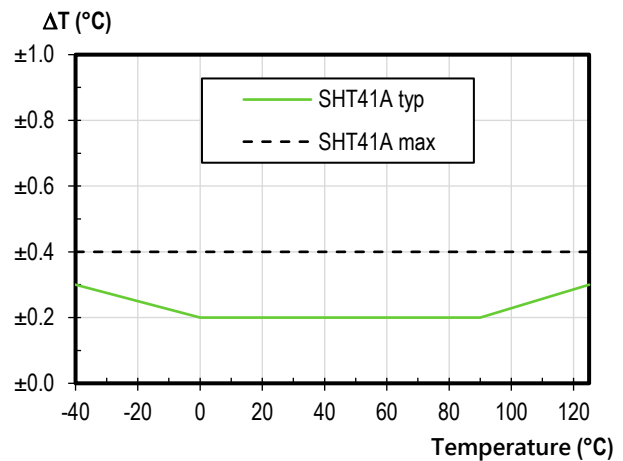

**Figure 7.** SHT41A typical and maximal temperature accuracy.

<sup>8</sup> Temperature response time depends on heat conductivity of sensor substrate and design-in of sensor in application.

<sup>9</sup> Max. value is <0.04°C/y.

## 2.4 Recommended Operating Conditions

The sensor shows best performance when operated within the recommended normal temperature and humidity range of 5 °C ... 60 °C and 20 %RH ... 80 %RH, respectively. Long term exposure to conditions outside recommended normal range, especially at high relative humidity, may temporarily offset the RH signal (e.g., +3 %RH after 60 h at >80 %RH). After returning into the recommended temperature and humidity range the sensor will recover to within specifications by itself. Prolonged exposure to extreme conditions may accelerate ageing.

The Sensors from Sensirions SHT4x Family show exceptional resistance to volatile organic compounds and ageing. To avoid contamination the conditions described in the document "Sensirion, Handling Instructions for Humidity Sensors, 2020 [1]" must be met. Please note as well that this does apply not only to transportation and manufacturing, but also to operation of the SHT4xA.

## 2.5 Design In

The above-mentioned specifications hold for the stand-alone sensing element. To achieve the best performance please consult the document Design in Guide [2] on our website Sensirion.com.



### 3 Electrical Specifications

Valid for all electrical specifications: Typical values correspond to VDD = 3.3 V and T = 25 °C. Min. and max. values are valid in the full temperature range -40 °C ... 125 °C, at declared VDD levels and are based on characterization.

Parameter	Symbol	Conditions	Min	Typ.	Max	Unit	Comments
Supply voltage	V <sub>DD</sub>	I2C, SHT4xA-xxLx	1.08	3.3	3.6	V	-
		I2C, SHT4xA-xx1x	2.3	3.3	5.5	V	-
		PWM	3.0	3.3	5.5	V	-
Power-up/down level	V <sub>POR</sub>	I2C, SHT4xA-xxLx: Static power supply	0.6	-	1.2	V	-
		I2C, SHT4xA-xx1x: Static power supply	0.7	-	2.3	V	-
Supply current (no heater)	I <sub>DD</sub>	I2C, Idle state	-	18	-	µA	-
		I2C, PWM Measurement	-	320	500	µA	Average current consumption while sensor is measuring
		I2C: Aver., high repeatability Aver., med. repeatab. Aver., low repeatab.	- - -	20 19 18	- - -	µA	Aver. current consumpt. (contin. operation at 1Hz)
		PWM	-	50	-	µA	Aver. current consumpt. (2Hz)
Low level input voltage	V <sub>IL</sub>	I2C	0	-	0.3*V <sub>DD</sub>	V	-
High level input voltage	V <sub>IH</sub>	I2C	0.7*V <sub>DD</sub>	-	V <sub>DD</sub>	V	-
Pull up resistors	R <sub>p</sub>	I2C, SHT4xA-xxLx: V <sub>DD</sub> ≥ 1.6V	390	-	-	Ω	-
		I2C, SHT4xA-xx1x: V <sub>DD</sub> < 3.0V	820	-	-		
		I2C, SHT4xA-xx1x: V <sub>DD</sub> ≥ 3.0V	390	-	-		
Low level output voltage	V <sub>OL</sub>	I2C, SHT4xA-xxLx: 2.0V > V <sub>DD</sub> ≥ 1.6V, R <sub>p</sub> ≥ 390 Ω	-	-	0.2*V <sub>DD</sub>	V	-
		I2C, SHT4xA-xxLx: V <sub>DD</sub> ≥ 2.0V, R <sub>p</sub> ≥ 390 Ω	-	-	0.4		
		I2C, SHT4xA-xx1x: V <sub>DD</sub> ≥ 2.3V, R <sub>p</sub> ≥ 820 Ω	-	-			
		I2C, SHT4xA-xx1x: V <sub>DD</sub> ≥ 3.0V, R <sub>p</sub> ≥ 390 Ω	-	-			
		PWM: R <sub>load</sub> > 100 kΩ	0	-	10%V <sub>DD</sub>		
High level output voltage	V <sub>OH</sub>	PWM: R <sub>load</sub> > 100 kΩ	90% V <sub>DD</sub>	-	V <sub>DD</sub>	V	-

**Table 3.** Electrical specifications (continuation on next page). "x" used as placeholder.

Parameter	Sym bol	Conditions	Min	Typ.	Max	Unit	Comments
Capac. bus load	C <sub>b</sub>	I2C: R <sub>p</sub> ≥ 820 Ω: fast mode	-	-	400	pF	Capac. bus load can be determined from C <sub>b</sub> < t <sub>rise</sub> / (0.8473 * R <sub>p</sub> ). Rise times are t <sub>rise</sub> = 300 ns for fast mode and t <sub>rise</sub> = 120 ns for fast mode plus
		I2C, SHT4xA-xxLx: R <sub>p</sub> ≥ 390 Ω, V <sub>DD</sub> ≥ 1.6 V: fast mode plus	-	-	340	pF	
		I2C: R <sub>p</sub> ≥ 390 Ω, V <sub>DD</sub> ≥ 3.0 V: fast mode plus					
		PWM	0	1	3	nF	-
PWM frequency	1/t <sub>F</sub>	PWM	95	122	150	Hz	Base frequency
Measurement frequency	-	PWM	-	2	-	Hz	Frequency with which the sensor acquires new values
PWM duty cycle	-	PWM	10	-	90	%	-

**Table 4.** Continued Electrical Specifications. “x” is used as a place holder variable, possible values see Table 11

### 3.1 Timings

Parameter	Symbol	Conditions	Min.	Typ.	Max.	Units	Comments
I2C: Power-up time	t <sub>PU</sub>	After hard reset, V <sub>DD</sub> ≥ V <sub>POR</sub>	-	0.3	1	ms	Time between V <sub>DD</sub> reaching V <sub>POR</sub> and sensor entering idle state
PWM: Power-up time	t <sub>PU</sub>	After hard reset, V <sub>DD</sub> ≥ V <sub>POR</sub>	-	5	10	ms	Time between V <sub>DD</sub> reaching V <sub>POR</sub> and sensor providing measurement data on output pins
I2C: Soft reset time	t <sub>SR</sub>	After soft reset	-	-	1	ms	Time between ACK of soft reset command and sensor entering idle state. Also valid for I2C general call reset.
I2C: Measurement duration	t <sub>MEAS,l</sub>	Low repeatability	-	1.3	1.6	ms	The three repeatability modes differ with respect to measurement duration, noise level and energy consumption
	t <sub>MEAS,m</sub>	Med. repeatability	-	3.7	4.5	ms	
	t <sub>MEAS,h</sub>	High repeatability	-	6.9	8.3	ms	
I2C: Heater-on duration	t <sub>Heater</sub>	Long pulse	0.81	1	1.19	s	After that time the heater is automatically switched off
		Short pulse	0.08	0.1	0.12	s	After that time the heater is automatically switched off

**Table 5.** System timing specifications.

### 3.2 Absolute Maximum Ratings

Stress levels beyond those listed in Table 6 may cause permanent damage or affect the reliability of the device. These are stress ratings only and functional operation of the device at these conditions is not guaranteed. Ratings are only tested each at a time.

Parameter	Rating
Supply voltage $V_{DD}$ , SHT4xA-xxLx	-0.3 V ... 4.0 V
Supply voltage $V_{DD}$	-0.3 V ... 6.0 V
Max. voltage on any pin	$V_{SS} - 0.3 V \dots V_{DD} + 0.3 V$
Operating temperature range	-40 °C ... 125 °C
Storage temperature range <sup>10</sup>	-40 °C ... 150 °C
ESD HBM	6 kV
ESD CDM	750 V
Latch up, JEDEC Class II, 125°C	±100 mA

Table 6. Absolute maximum ratings.

## 4 Sensor Operation

### 4.1 I2C Communication

I2C communication is based on NXP’s I2C-bus specification and user manual UM10204, Rev.6, 4 April 2014. Supported I2C modes are standard, fast mode, and fast mode plus. Data is transferred in multiples of 16-bit words. In order to increase reliability of data transfer, I2C glitch protection is offered in form of 8-bit checksum (cyclic redundancy check = CRC, see section 4.4). All transfers must begin with a start condition (S) and terminate with a stop condition (P). To finish a read transfer, send not acknowledge (NACK) and stop condition (P). Addressing a specific slave device is done by sending its 7-bit I2C address followed by an eighth bit, denoting the communication direction: “zero” indicates transmission to the slave, i.e. “write”, a “one” indicates a “read” request. Schematics of the I2C transfer types are sketched in Figure 8.

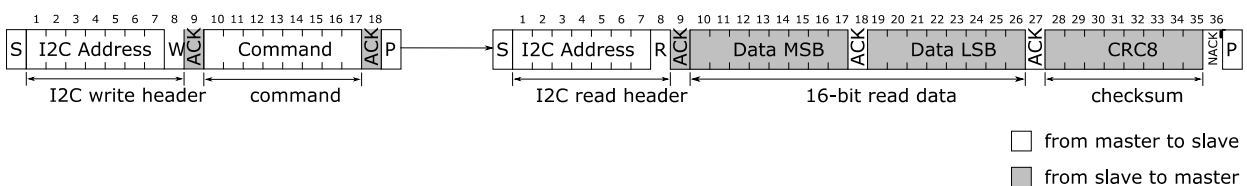

Figure 8. I2C transfer types: First a write header is sent to the I2C slave, followed by a command, for example “measure RH&T with highest precision”. After the measurement is finished the read request directed to this I2C slave will be acknowledged and transmission of data will be started by the slave.

#### 4.1.1 I2C Communication Timing

All details on the timing are following the interface specification of NXP’s user manual UM10204, Rev.6, 4 April 2014. Please follow mandatory capacitor and resistor requirements given in Table 3.

<sup>10</sup> The recommended storage temperature range is 10-50 °C. Please consult (Sensirion, *Handling Instructions for Humidity Sensors*, 2020 [1]) for more information.

## 4.2 I2C Data type & length

I2C bus operates with 8-bit data packages. Information from the sensor to the master has a checksum after every second 8-bit data package.

Humidity and temperature data will always be transmitted in the following way: The first value is the temperature signal (2 \* 8-bit data + 8-bit CRC), the second is the humidity signal (2 \* 8-bit data + 8-bit CRC).

## 4.3 I2C Checksum Calculation

For read transfers each 16-bit data is followed by a checksum with the following properties

Property	Value
Name	CRC-8
Message Length	16-bit
Polynomial	0x31 ( $x^8 + x^5 + x^4 + 1$ )
Initialization	0xFF
Reflect Input/Output	false/false
Final XOR	0x00
Examples	CRC(0xBEEF) = 0x92

**Table 7.** Data check sum properties

The master may abort a read transfer after the 16-bit data if it does not require a checksum.

#### 4.4 I2C Command Overview

Command (hex)	Response length incl. CRC (bytes)	Description [return values]
0xFD	6	measure T & RH with high precision (high repeatability) [2 * 8-bit T-data; 8-bit CRC; 2 * 8-bit RH-data; 8-bit CRC]
0xF6	6	measure T & RH with medium precision (medium repeatability) [2 * 8-bit T-data; 8-bit CRC; 2 * 8-bit RH-data; 8-bit CRC]
0xE0	6	measure T & RH with lowest precision (low repeatability) [2 * 8-bit T-data; 8-bit CRC; 2 * 8-bit RH-data; 8-bit CRC]
0x89	6	read serial number [2 * 8-bit data; 8-bit CRC; 2 * 8-bit data; 8-bit CRC]
0x94	-	soft reset [ACK]
0x39	6	activate heater with 200mW for 1s, including a high precision measurement just before deactivation [2 * 8-bit T-data; 8-bit CRC; 2 * 8-bit RH-data; 8-bit CRC]
0x32	6	activate heater with 200mW for 0.1s including a high precision measurement just before deactivation [2 * 8-bit T-data; 8-bit CRC; 2 * 8-bit RH-data; 8-bit CRC]
0x2F	6	activate heater with 110mW for 1s including a high precision measurement just before deactivation [2 * 8-bit T-data; 8-bit CRC; 2 * 8-bit RH-data; 8-bit CRC]
0x24	6	activate heater with 110mW for 0.1s including a high precision measurement just before deactivation [2 * 8-bit T-data; 8-bit CRC; 2 * 8-bit RH-data; 8-bit CRC]
0x1E	6	activate heater with 20mW for 1s including a high precision measurement just before deactivation [2 * 8-bit T-data; 8-bit CRC; 2 * 8-bit RH-data; 8-bit CRC]
0x15	6	activate heater with 20mW for 0.1s including a high precision measurement just before deactivation [2 * 8-bit T-data; 8-bit CRC; 2 * 8-bit RH-data; 8-bit CRC]

**Table 8.** Overview of I2C commands. If the sensor is not ready to process a command, e.g. because it is still measuring, it will return NACK to the I2C read header. **For SHT4xA-xx1x, i.e. for all product variants with VDD = 2.3 V ... 5.5 V:** Given heater power values are typical and valid for VDD = 5 V. At VDD = 3.3 V, heating power is reduced to 5% of the nominal value. **For SHT4xA-xxLx, i.e. for all product variants with VDD = 1.08V ... 3.6 V:** Given heater power values are typical and valid for VDD = 3.3 V. At VDD = 1.8 V, heating power is reduced to 20% of the nominal value.

#### 4.5 Conversion of Signal Output

The digital sensor signals correspond to following humidity and temperature values:

$$RH = \left( -6 + 125 \cdot \frac{S_{RH}}{2^{16} - 1} \right) \%RH \quad 1$$

$$T = \left( -45 + 175 \cdot \frac{S_T}{2^{16} - 1} \right) ^\circ C \quad 2$$

$$T = \left( -49 + 315 \cdot \frac{S_T}{2^{16} - 1} \right) ^\circ\text{F}$$

3

N.B.: The RH conversion formula (1) allows values to be reported which are outside of the range of 0 %RH ... 100 %RH. Relative humidity values which are smaller than 0 %RH and larger than 100 %RH are non-physical, however these "uncropped" values might be found beneficial in some cases (e.g. when the distribution of the sensors at the measurement boundaries are of interest). For all users who don't want to engage in evaluation of these non-physical values, cropping of the RH signal to the range of 0 %RH ... 100 %RH is advised. N.B. 2: From a computational perspective, in formulae (1), ( 2 ), and ( 3 ) the division by 2<sup>16</sup>-1 can be simplified to a division by only 2<sup>16</sup>. The introduced accuracy deviations are <0.002 %RH and <0.003 °C, respectively.

### 4.6 Serial Number

Every single sensor has a unique serial number, that is assigned by Sensirion during production. It is stored in the one-time-programmable memory and cannot be manipulated after production. The serial number is accessible via I2C and is transmitted as two 16-bit words, each followed by an 8-bit CRC.

### 4.7 I2C Heater Operation

The sensor incorporates an integrated on-chip heater which can be switched on by the set of commands given **Table 7**. There are three different heating powers and two different heating times accessible to the user which are given in . After reception of a heater-on command, the sensor executes the following procedure:

1. The heater is enabled, and the timer starts its count-down.F
2. On timer expiration a temperature and humidity measurement with the highest repeatability is started, the heater remains enabled.
3. After the measurement is finished the heater is turned off.
4. Temperature and humidity values are now available for readout.

The maximum on-time of the heater commands is 1 second in order to prevent overheating of the sensor by unintended usage of the heater. Thus, there is no dedicated command to turn off the heater. For extended heating periods it is required to send periodic heater-on commands, keeping in mind that the heater is designed for a maximal duty cycle of less than 10%. To obtain a fast increase in temperature the idle time between consecutive heating pulses shall be kept minimal.

Parameter	Selectable Values
Heater Power At VDD = 5 V for SHT4xA-xx1x At VDD = 3.3 V for SHT4xA-xxLx	0 (=off), 20, 110, 200 mW
Heater-on Duration (t <sub>Heat</sub> )	0.1, 1 s
Maximal duty cycle	10%

**Table 9.** SHT4xA heater specifications. For SHT4xA-xx1x, i.e. for all product variants with VDD = 2.3 V ... 5.5 V: Given heater power values are typical and valid for VDD = 5 V. At VDD = 3.3 V, heating power is reduced to 5% of the nominal value. For SHT4xA-xxLx, i.e. for all product variants with VDD = 1.08V ... 3.6 V: Given heater power values are typical and valid for VDD = 3.3 V. At VDD = 1.8 V, heating power is reduced to 20% of the nominal value.

## 4.8 Possible Heater Use Cases

Please refer to the dedicated Sensirion application notes elaborating on various use cases of the heater. In general, the applications of the on-chip heater cover:

1. Removal of condensed / spray water on the sensor surface. Although condensed water is not a reliability / quality problem to the sensor, it will however make the sensor non-responsive to RH changes in the air as long as there is liquid water on the surface.
2. Drift-free operation in high humid environments. Periodic heating pulses allow for drift-free high-humidity measurements over extended periods of times.

## 4.9 Important notes for operating the heater:

1. For all SHT4xA-xx1x versions, the heater is designed for a maximum duty cycle of 10%, meaning the total heater-on-time should not be longer than 10% of the sensor's lifetime. For all SHT4xA-xxLx versions, the maximum duty cycle of the heater is 5%.
2. During operation of the heater, sensor specifications are not valid.
3. The temperature sensor can additionally be affected by the thermally induced mechanical stress, offsetting the temperature reading from the actual temperature.
4. The sensor's temperature (base temperature + temperature increase from heater) must not exceed  $T_{max} = 125\text{ °C}$  to have proper electrical functionality of the chip.
5. The heater draws a large amount of current once enabled. In the highest power setting it is up to ~50 mA for all SHT4xA-xx1x versions and up to ~75 mA for all SHT4xA-xxLx versions. Although a dedicated circuitry draws this current smoothly, the power supply must be strong enough to avoid large voltage drops that could provoke a sensor reset.
6. If higher heating temperatures are desired, consecutive heating commands can be sent to the sensor. To keep times between consecutive heating pulses minimal, polling of the sensor is advised. The heater shall only be operated in ambient temperatures below 65 °C or else it could drive the sensor outside of its maximal operating temperature.

## 4.10 Pulse-Width Modulation (PWM) interface

The sensor can be ordered with a pre-configured pulse width modulation (PWM) interface. This is a permanent interface configuration and cannot be changed by the user.

After power-up of the sensor, it needs at most 10 ms until providing measurement data as PWM bit-stream on the respective output pins (see **Figure 13**). During that time the temperature and humidity pins have an undefined state.

The PWM is based on a constant base frequency with period  $t_F$ , as shown in **Figure 9**. The humidity and temperature signals are provided as duty cycle ( $t_{PW}/t_F$ ) on that base frequency. A ratio of *e.g.*  $t_{PW\_RH}/t_F = 0.1$  corresponds to RH = -6 %RH while a ratio of *e.g.*  $t_{PW\_RH}/t_F = 0.9$  corresponds to RH = 119 %RH.

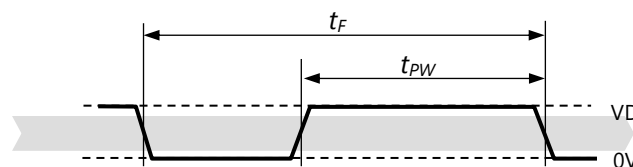

**Figure 9.** PWM signal: The base frequency of  $1/t_F$  remains constant, whereas  $t_{PW}$  is variable. The physical signal of temperature and humidity is provided as  $t_{PW}/t_F$  on the respective pins.

## 4.11 PWM Conversion of Signal Output

Measurement data is linearized and compensated for temperature and supply voltage effects by the sensor. The provided pulse widths  $t_{PW\_RH}$  and  $t_{PW\_Temp}$  are translated into humidity and temperature values by the following formulae, respectively:

$$RH = \left( -21.625 + 156.25 \cdot \frac{t_{PW\_RH}}{t_F} \right) \%RH \quad 4$$

$$T = \left( -45 - \frac{17.5}{0.8} + \frac{175}{0.8} \cdot \frac{t_{PW\_Temp}}{t_F} \right) ^\circ C \quad 5$$

$$T = \left( -49 - \frac{31.5}{0.8} + \frac{315}{0.8} \cdot \frac{t_{PW\_Temp}}{t_F} \right) ^\circ F \quad 6$$

## 4.12 Reset

A reset of the sensor can be achieved in three ways:

- I2C Soft reset: send the reset command described in **Table 7**.
- I2C general call: all devices on I2C bus are reset by sending the command 0x06 to the I2C address 0x00.
- Power down (*incl.* pulling SCL and SDA low)

# 5 Physical Specification

## 5.1 Package Description

SHT4xA is provided in an open-cavity dual flat no lead (DFN) package. The humidity sensor opening is centered on the top side of the package. The sensor chip is made of silicon, hosted on a copper lead frame and overmolded by an epoxy-based mold compound. Exposed bottom side of the leadframe with the metallic contacts is Ni/Pd/Au coated, side walls are bare copper.

Moisture sensitivity level (MSL) of 1 according to IPC/JEDEC J-STD-020 is achieved. It is recommended to process the sensors within one year of the date of delivery.



### 5.2 Package Outline – Standard Package

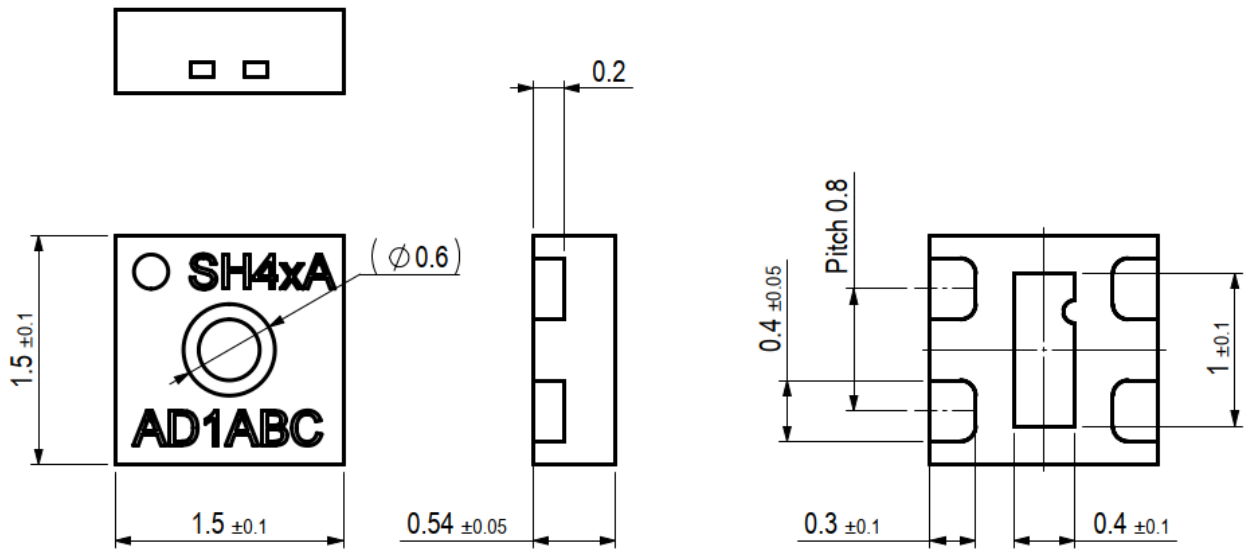

Figure 10. Dimensional drawing of SHT4xA including package tolerances (units mm).

### 5.3 Package Outline – Package with Wettable Flanks

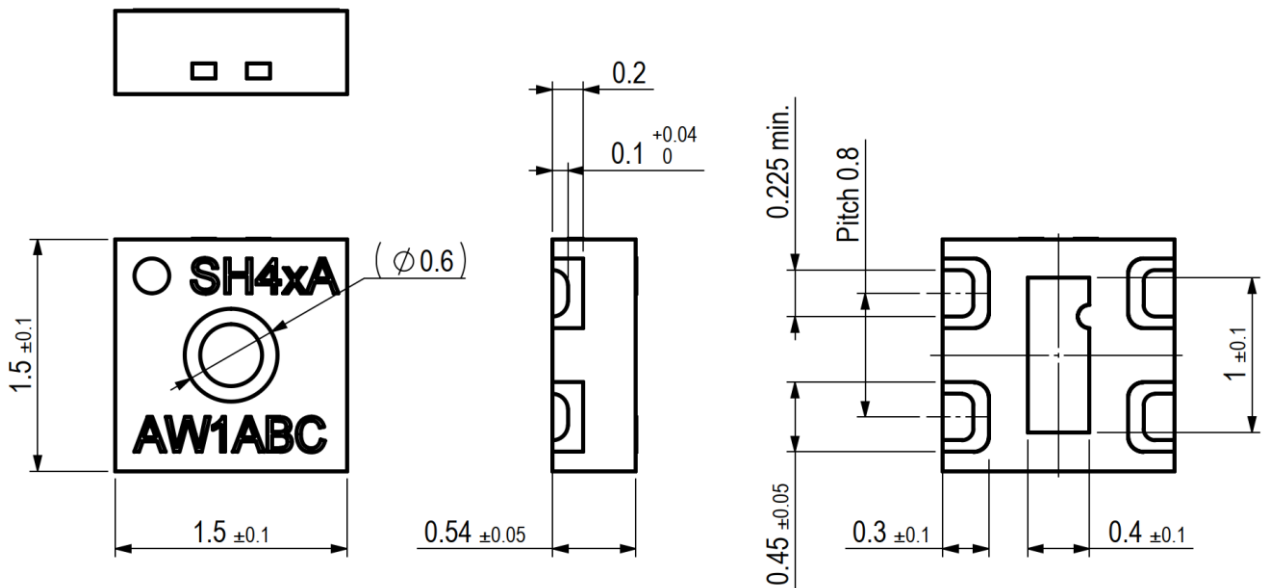
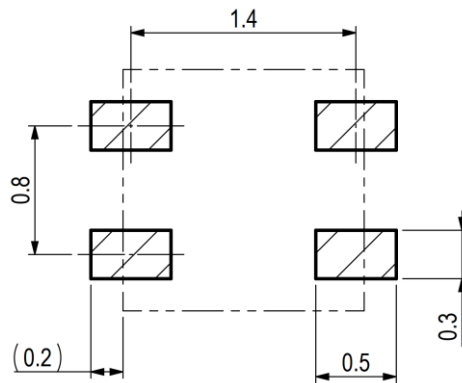

Figure 11. Dimensional drawing of SHT4xA with wettable flanks, including package tolerances (units mm).

### 5.4 Land Pattern– Package with Wettable Flanks

The land pattern is recommended to be designed according to the used PCB and soldering process together with the physical outer dimensions of the sensor. For reference, the land pattern used with Sensirion’s PCBs and soldering processes is given in **Figure 10** & **Figure 11** for the wettable flanks option. Soldering of the central die pad, as well as an exposed copper pad underneath it, is not recommended by Sensirion due to it acting as a heat sink which prevents the heater from functioning according to its specifications.



**Figure 12.** Recommended land pattern (in mm). Details can vary and depend on used PCBs and solder processes. There shall be no copper under the sensor other than at the pin pads.

### 5.5 Pin Assignment & Laser Marking

Pin	Name		Comments	
	I2C	PWM	I2C	PWM
1	SDA	RH	Serial data, bidirectional	RH out
2	SCL	T	Serial clock, unidirectional input	T out
3	VDD		Supply voltage	
4	VSS		Ground	

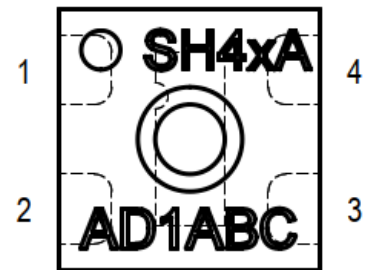

**Figure 13.** Pin assignment (transparent top view). Dashed lines are only visible if the sensor is viewed from below. The die pad is not directly connected to any pin.

The laser marking consists of two lines, indicated in **Figure 13**. In the first line a filled circle serves as pin-1 indicator and is followed by "SH4". The fourth character will indicate the accuracy class of this product (here "x" serves as place holder). Last "A" indicates the automotive grade. In the second line, the first three characters specify the product characteristics according to positions 8, 9 and 10 of **Table 11** second three characters serve as internal batch tracking code.

## 5.6 Thermal Information

Symbol	Description	Heater off, die pad soldered (K/W)		Heater on, die pad soldered (K/W)		Heater off, <b>die pad not solder.</b> (K/W)		Heater on, <b>die pad not solder.</b> (K/W)	
		DFN	DFN+WF	DFN	DFN+WF	DFN	DFN+WF	DFN	DFN+WF
$R_{\theta JA}$	Junction-to-ambie. thermal resistance	246	258	308	329	<b>297</b>	<b>322</b>	<b>357</b>	<b>390</b>
$R_{\theta JC}$	Junction-to-case thermal resistance	189	183	255	252	<b>191</b>	<b>188</b>	<b>257</b>	<b>254</b>
$R_{\theta JB}$	Junction-to-board thermal resistance	159	177	225	242	<b>193</b>	<b>219</b>	<b>258</b>	<b>284</b>
$\Psi_{JB}$	Junction-to-board characteriz. param.	159	171	223	242	<b>191</b>	<b>213</b>	<b>254</b>	<b>282</b>
$\Psi_{JT}$	Junction-to-top characteriz. param.	38	35	105	104	<b>44</b>	<b>42</b>	<b>112</b>	<b>111</b>

**Table 10.** Typical values for thermal metrics. In the “heater on” columns a heater power of 200 mW wasco assumed. Soldering the die pad is not recommended, therefore the two right hand side columns are bold. The sub-columns labelled “DFN+WF” display the results for the DFN package with soldered wettable flanks terminals. Values are based on simulation.

## 6 Safety Element out of context (SEooC)

The SHT41A is available as a “Safety element out of context (SEooC)” developed according to ISO 26262 which meets the automotive safety integrity level (ASIL) A. The functional safety base failure rates (FIT) can be found in the respective Application Note [3]. For access to the Diagnose Manual and Safety Manual please contact Sensirion directly.

## 7 Quality and Material Contents

Qualification of SHT4xA is performed based on the AEC Q100 qualification test method. The device is fully RoHS and WEEE compliant, e.g. free of Pb, Cd, and Hg. For general remarks of best practice in processing humidity sensor please refer to (Sensirion, Handling Instructions for Humidity Sensors, 2020 [1]).

## 8 Tape and Reel Packaging

All specifications for the tape and reel packaging can be found on **Figure 14**. Reel diameters are 13 inch and 8 inch for the 10k and the 2.5k packaging sizes, respectively.

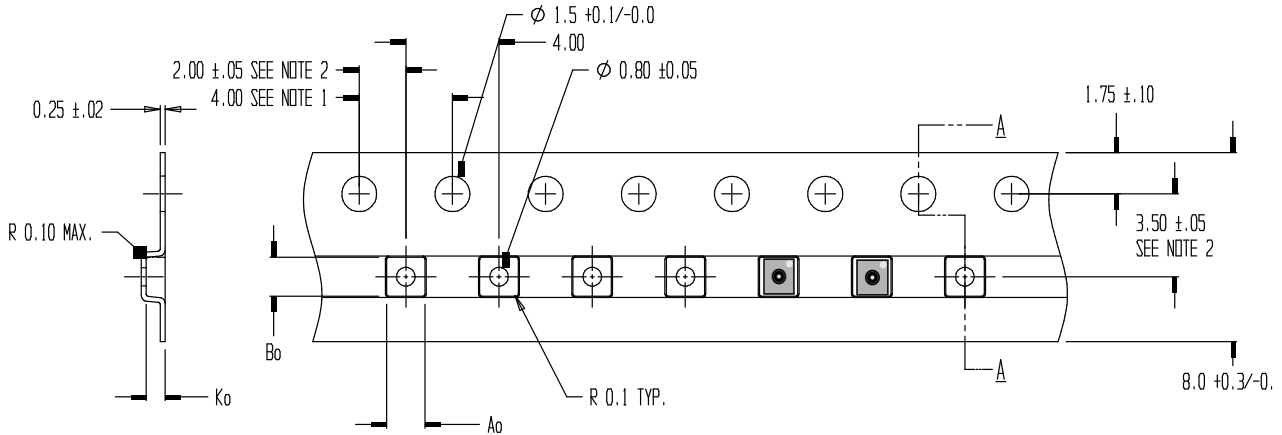

- NOTES:
- 1. 10 SPROCKET HOLE PITCH CUMULATIVE TOLERANCE  $\pm 0.2$
  - 2. POCKET POSITION RELATIVE TO SPROCKET HOLE MEASURED AS TRUE POSITION OF POCKET, NOT POCKET HOLE
  - 3.  $A_0$  AND  $B_0$  ARE CALCULATED ON A PLANE AT A DISTANCE "R" ABOVE THE BOTTOM OF THE POCKET.
- |                       |                                    |  |
|-----------------------|------------------------------------|--|
| $A_0 = 1.65 \pm 0.05$ | TOLERANCES - UNLESS                |  |
| $B_0 = 1.65 \pm 0.05$ | NOTED 1PL $\pm 0.2$ 2PL $\pm 0.10$ |  |
| $K_0 = 0.81 \pm 0.05$ |                                    |  |

**Figure 14.** Tape and reel specifications including sensor orientation in pocket (see indication of two sensors on the right side of the tape).

## 9 Product Nomenclature

Position	Value(s)	Explanation
1	S	Sensirion
2	H	humidity signal
3	T	temperature signal
4	4	fourth product generation
5	0	$\pm 3$ %RH / $\pm 0.3$ °C
	1	$\pm 2$ %RH / $\pm 0.2$ °C
6	A	automotive version
7	-	delimiter
8	A	I2C interface with 0x44 address
	B	I2C interface with 0x45 address
	F	PWM Interface
9	D	DFN package
	W	DFN package with wettable flanks
10	1	VDD = 2.3 V ... 5.5 V
	L	VDD = 1.08 V ... 3.6 V
	S	ASIL-A Safety Element out of Context (SEooC)
11	B	blank package
12	-	delimiter
13	R	tape on reel packaging
14	2	reel contains 2'500 pieces
	3	reel contains 10'000 pieces

**Table 11.** SHT4xA product nomenclature.

## 10 Ordering Information

Material Description	Material Number	Details	Quantity (pcs)
SHT40A-AD1B-R2	3.000.546	±3 %RH / ±0.3 °C, 0x44 I2C addr., VDD = 2.3 V ... 5.5 V	2'500
SHT40A-AD1B-R3	3.000.672	±3 %RH / ±0.3 °C, 0x44 I2C addr., VDD = 2.3 V ... 5.5 V	10'000
SHT40A-FD1B-R2	3.000.676	±3 %RH / ±0.3 °C, PWM interface, VDD = 2.3 V ... 5.5 V	2'500
SHT40A-FD1B-R3	3.000.673	±3 %RH / ±0.3 °C, PWM interface, VDD = 2.3 V ... 5.5 V	10'000
SHT40A-AW1B-R2	3.000.677	±3 %RH / ±0.3 °C, 0x44 I2C addr., wetable flanks, VDD = 2.3 V ... 5.5 V	2'500
SHT40A-AW1B-R3	3.000.674	±3 %RH / ±0.3 °C, 0x44 I2C addr., wetable flanks, VDD = 2.3 V ... 5.5 V	10'000
SHT41A-AD1B-R2	3.000.551	±2 %RH / ±0.2 °C, 0x44 I2C addr., VDD = 2.3 V ... 5.5 V	2'500
SHT41A-AD1B-R3	3.000.624	±2 %RH / ±0.2 °C, 0x44 I2C addr., VDD = 2.3 V ... 5.5 V	10'000
SHT41A-BD1B-R2	3.000.798	±2 %RH / ±0.2 °C, 0x45 I2C addr., VDD = 2.3 V ... 5.5 V	2'500
SHT41A-BD1B-R3	3.000.797	±2 %RH / ±0.2 °C, 0x45 I2C addr., VDD = 2.3 V ... 5.5 V	10'000
SHT41A-FD1B-R2	3.000.658	±2 %RH / ±0.3 °C, PWM interface, VDD = 2.3 V ... 5.5 V	2'500
SHT41A-AW1B-R2	3.000.552	±2 %RH / ±0.2 °C, 0x44 I2C addr., wetable flanks, VDD = 2.3 V ... 5.5 V	2'500
SHT41A-AW1B-R3	3.000.675	±2 %RH / ±0.2 °C, 0x44 I2C addr., wetable flanks, VDD = 2.3 V ... 5.5 V	10'000
SHT41A-AWLB-R2	3.000.930 Samples available	±2 %RH / ±0.2 °C, 0x44 I2C addr., wetable flanks, VDD = 1.08 V ... 3.6 V	2'500
SHT41A-AWLB-R3	3.000.931 Samples available	±2 %RH / ±0.2 °C, 0x44 I2C addr., wetable flanks, VDD = 1.08 V ... 3.6 V	10'000
SHT41A-AWSB-R3	3.001.058	Safety element out of context ±2 %RH / ±0.2 °C, 0x44 I2C addr., wetable flanks, VDD = 2.3 V ... 5.5 V	10'000

**Table 12.** SHT4xA ordering options.

## 11 Bibliography

- [1] Sensirion, "Handling Instructions for Humidity Sensors," 2020. [Online]. Available: [www.sensirion.com](http://www.sensirion.com).
- [2] Sensirion, "SHTxx Design Guide," [Online]. Available: [www.sensirion.com](http://www.sensirion.com).
- [3] Sensirion, "Functional safety base failure rates," 2024. [Online]. Available: <https://www.sensirion.com/products/downloads>.

## Revision History

Date	Version	Page(s)	Changes
January 2022	1	All 5 9 16	First release Updated drift specification in <b>Table 1</b> Updated max. current in <b>Table 3</b> Updated formula (4) and PWM description
July 2022	2	4 7 7 17	Added SnapEDA link in section 1 Corrected typo in caption of <b>Figure 7</b> Corrected erratum in caption of <b>Table 7</b> : old: "... valid for VDD=3.3V" new: "... valid for VDD=5V" Introduced new section 5.4 describing wettable flanks pack.
October 2022	3	22	Introduced alternative I2C-address products in <b>Table 12</b>
March 2023	4	Multiple Multiple 9 13 7	Introduced low voltage variant SHT4xA-xxLx in ' <i>Features, 'Device Overview', Table 3, Table 11, Table 12</i> Updated capacitive bus load of PWM interface in <b>Table 3</b> Added comment on conversion formulae in section 4.5 Improved temperature accuracy of SHT41A in <b>Figure 7</b>
June 2023	4.1	All 13	Typo Correction and reformatting into new Sensirion DS Including: wrongful referencing in text to equation 1,2&3
October 2023	4.2	Multiple 1 6 8 9 11 14	Updated font and reformatted <b>Table 3 &amp; Table 4</b> Added I2C and PWM options in Device Overview Updated <b>Figure 4 &amp; Figure 5</b> with 25°C Column Edited ageing and voc subsection Min VDD updated to 1.08 V in <b>Table 3</b> Updated section 4.1 Added <b>Table 9</b> with heater parameters
November 2023	4.3	14	Corrected heater power in <b>Table 9</b>
December 2023	4.4	1 21 22	Updated VDD in Device Overview Updated VDD in <b>Table 11</b> Updated VDD in <b>Table 12</b>
April 2024	4.5	Multiple 11 17	Corrected ESD HBM value to 6 kV Added Land Pattern image, clarified wording
July 2024	5	Multiple 10 19 22	Added ASIL-A SEooC Sensor Added PWM duty cycle specification in <b>Table 4</b> Added SEooC information in section 6 Updated Ordering Information in <b>Table 12</b>
February 2025	5.1	21 22	Minor text update Updated Ordering information in <b>Table 12</b>



## Important Notices

### Warning, Personal Injury

Do not use this product as safety or emergency stop devices or in any other application where failure of the product could result in personal injury. Do not use this product for applications other than its intended and authorized use. Before installing, handling, using or servicing this product, please consult the data sheet and application notes. Failure to comply with these instructions could result in death or serious injury.

If the Buyer shall purchase or use SENSIRION products for any unintended or unauthorized application, Buyer shall defend, indemnify and hold harmless SENSIRION and its officers, employees, subsidiaries, affiliates and distributors against all claims, costs, damages and expenses, and reasonable attorney fees arising out of, directly or indirectly, any claim of personal injury or death associated with such unintended or unauthorized use, even if SENSIRION shall be allegedly negligent with respect to the design or the manufacture of the product.

### ESD Precautions

The inherent design of this component causes it to be sensitive to electrostatic discharge (ESD). To prevent ESD-induced damage and/or degradation, take customary and statutory ESD precautions when handling this product. See application note "ESD, Latchup and EMC" for more information.

### Warranty

SENSIRION warrants solely to the original purchaser of this product for a period of 12 months (one year) from the date of delivery that this product shall be of the quality, material and workmanship defined in SENSIRION's published specifications of the product. Within such period, if proven to be defective, SENSIRION shall repair and/or replace this product, in SENSIRION's discretion, free of charge to the Buyer, provided that:

- notice in writing describing the defects shall be given to SENSIRION within fourteen (14) days after their appearance;
- such defects shall be found, to SENSIRION's reasonable satisfaction, to have arisen from SENSIRION's faulty design, material, or workmanship;
- the defective product shall be returned to SENSIRION's factory at the Buyer's expense; and
- the warranty period for any repaired or replaced product shall be limited to the unexpired portion of the original period.

This warranty does not apply to any equipment which has not been installed and used within the specifications recommended by SENSIRION for the intended and proper use of the equipment. EXCEPT FOR THE WARRANTIES EXPRESSLY SET FORTH HEREIN, SENSIRION MAKES NO WARRANTIES, EITHER EXPRESS OR IMPLIED, WITH RESPECT TO THE PRODUCT. ANY AND ALL WARRANTIES, INCLUDING WITHOUT LIMITATION, WARRANTIES OF MERCHANTABILITY OR FITNESS FOR A PARTICULAR PURPOSE, ARE EXPRESSLY EXCLUDED AND DECLINED.

SENSIRION is only liable for defects of this product arising under the conditions of operation provided for in the data sheet and proper use of the goods. SENSIRION explicitly disclaims all warranties, express or implied, for any period during which the goods are operated or stored not in accordance with the technical specifications.

SENSIRION does not assume any liability arising out of any application or use of any product or circuit and specifically disclaims any and all liability, including without limitation consequential or incidental damages. All operating parameters, including without limitation recommended parameters, must be validated for each customer's applications by customer's technical experts. Recommended parameters can and do vary in different applications.

SENSIRION reserves the right, without further notice, (i) to change the product specifications and/or the information in this document and (ii) to improve reliability, functions and design of this product.

### Headquarters and Subsidiaries

#### Sensirion AG

Laubisruetistr. 50  
CH-8712 Staefa ZH  
Switzerland

phone: +41 44 306 40 00  
fax: +41 44 306 40 30  
[info@sensirion.com](mailto:info@sensirion.com)  
[www.sensirion.com](http://www.sensirion.com)

#### Sensirion Taiwan Co. Ltd

phone: +886 2 2218-6779  
[info@sensirion.com](mailto:info@sensirion.com)  
[www.sensirion.com](http://www.sensirion.com)

#### Sensirion Inc., USA

phone: +1 312 690 5858  
[info-us@sensirion.com](mailto:info-us@sensirion.com)  
[www.sensirion.com](http://www.sensirion.com)

#### Sensirion Japan Co. Ltd.

phone: +81 45 270 4506  
[info-jp@sensirion.com](mailto:info-jp@sensirion.com)  
[www.sensirion.com/jp](http://www.sensirion.com/jp)

#### Sensirion Korea Co. Ltd.

phone: +82 31 337 7700~3  
[info-kr@sensirion.com](mailto:info-kr@sensirion.com)  
[www.sensirion.com/kr](http://www.sensirion.com/kr)

#### Sensirion China Co. Ltd.

phone: +86 755 8252 1501  
[info-cn@sensirion.com](mailto:info-cn@sensirion.com)  
[www.sensirion.com/cn](http://www.sensirion.com/cn)

To find your local representative, please visit  
[www.sensirion.com/distributors](http://www.sensirion.com/distributors)